

## Sink Quadra R12

Kitchen Sinks

Code: 1718 850



### DETAILS

Material AISI 304 stainless steel

---

Texture Brushed in line

---

Finish Foster brushed

---

Edge/Installation Type Undermount

---

Base 90 cm

---

Dimensions 840 x 440 mm

---

Bowl dimension 800 x 400 mm

---

Width 84 cm

---

Built-in hole [View technical data sheet](#)

---

Number of bowls 1 bowl

---

Standard fittings Fixing hooks, drain, overflow and siphon, boxed packing

---

Drainer No

---

Mixer holes No standard holes

---

Waste fitting Drain SPACE 3,5"

---

## FEATURES

**Deep bowls** This bowls reach an important depth, over 20 cm, thanks to the advanced production technology, that can be offer great capiciency and practicity in all the washing operations.

---

**Diamond-shape bottom** The draining of water is an important feature in a sink, and it's always taken good care of in Foster products. In the bent-welded sinks, which would have a flat bottom, the proper draining is guaranteed by the elegant beveling, which helps the water flow.

---

**High thickness** 1mm thick steel. A significant thickness, which guarantees the maximum sturdiness and durability.

---

**Perimetral overflow** The overflow is always a security on the Foster sinks that prevents the overflow of water in case of oversights. The perimeter drain solution improves aesthetics thanks to its square and essential shape.

---

**Small radius** Bowls with squared shapes with a modern design and an increased capacity, for a minimal aesthetics connected with an extreme practicity.

---

## TECHNICAL DATA

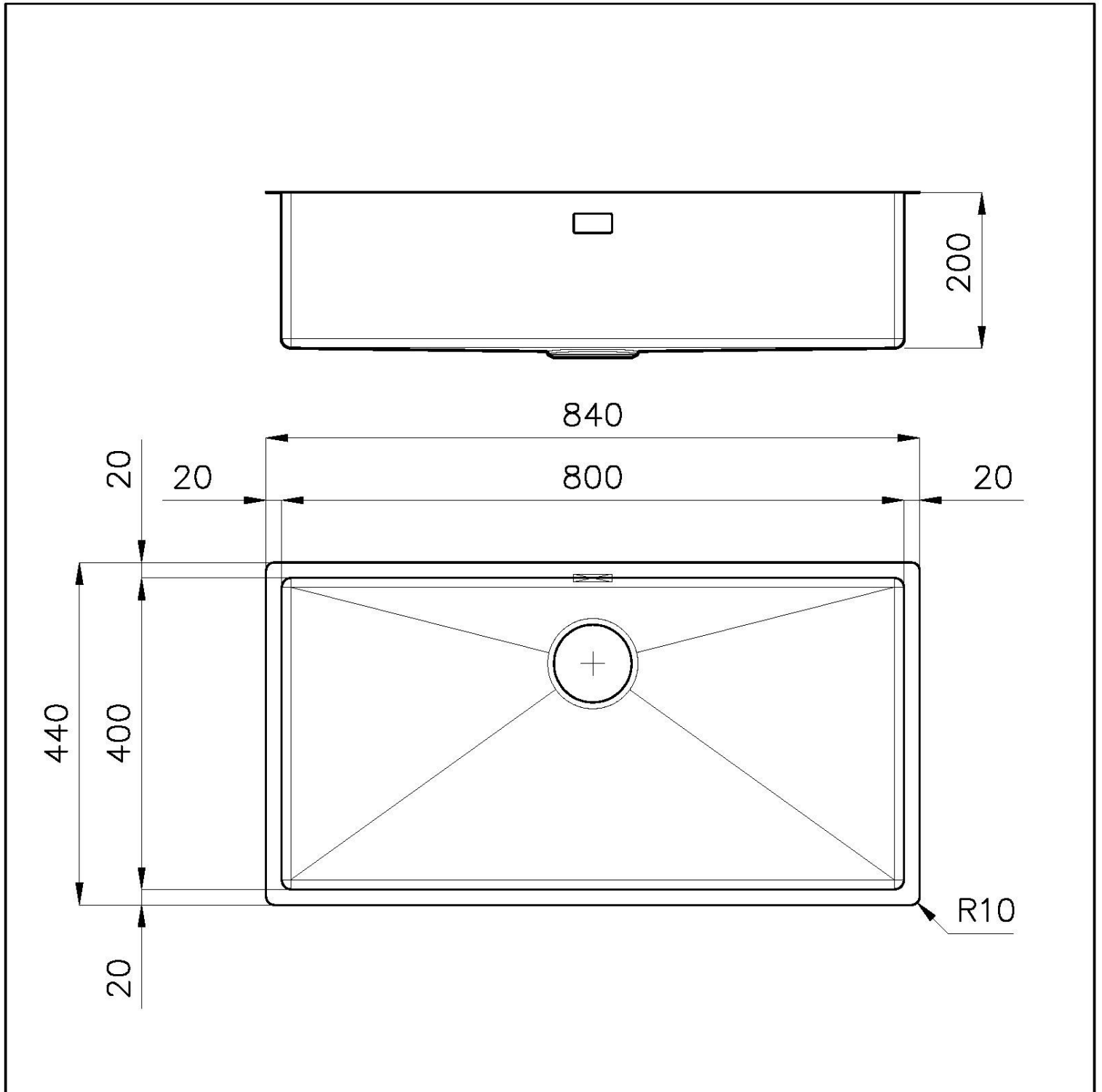

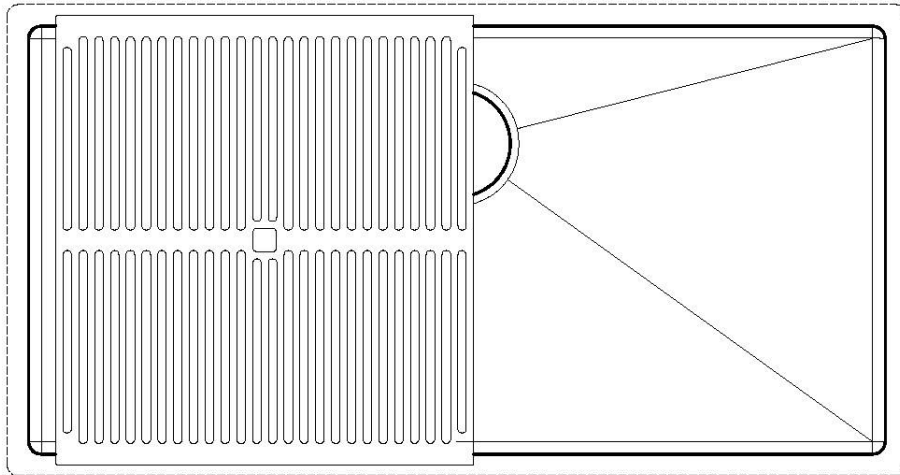

**8100 617**  
**POSIZIONATA A FILO VASCA / EDGE POSITIONING**

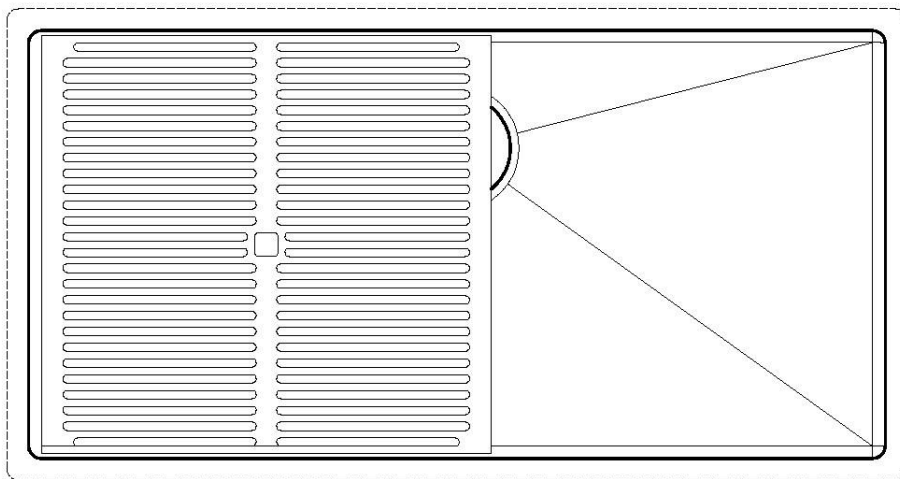

**8100 617**  
**POSIZIONATA SUL FONDO / BOTTOM POSITIONING**

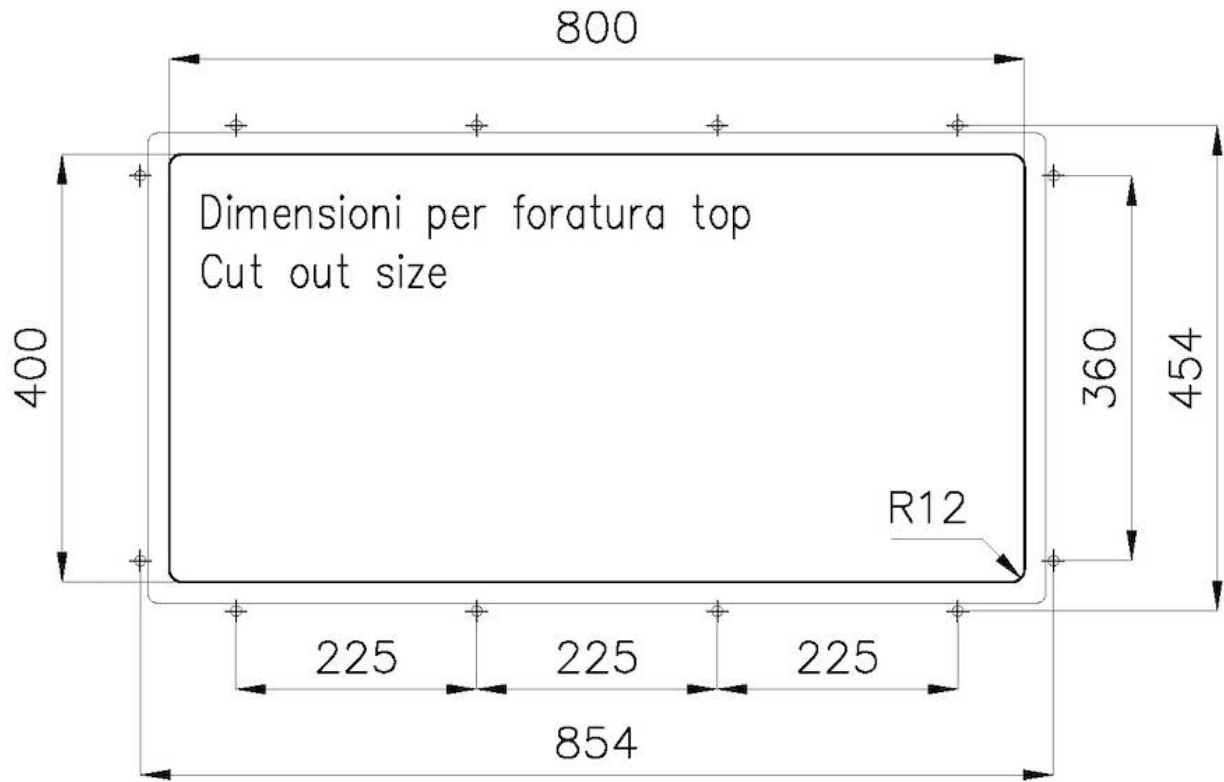

## GALLERY

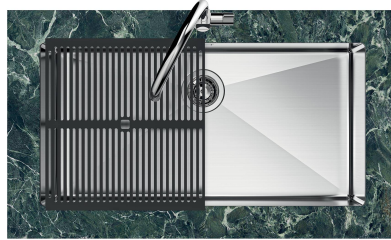
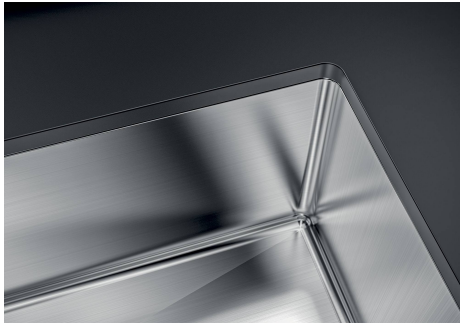

## EQUIPMENT



**Black grid**  
8100 617

## OPTIONAL ACCESSORIES



**Glass chopping board**  
8631 300



**Graters kit with ring-holder and food collection tray**  
8159 101  
\* only in combination with the accessory 8644 101



**HDPE Chopping board**  
8657 001



**HPDE Twin chopping board**  
8644 101



**Iroko-wood sliding chopping board with stainless steel colander**  
8644 044



**Stainless steel perforated tray**  
8151 000  
\* only in combination with the accessory 8644 101



**Stainless steel perforated tray PVD Copper**  
8151 008



**Stainless steel perforated tray PVD Gold**  
8151 009



**Stainless steel perforated tray PVD Gun Metal**  
8151 006

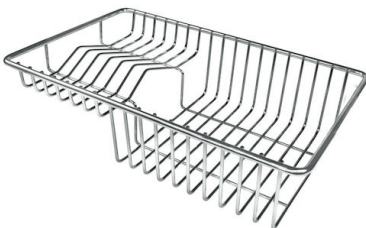

**Stainless steel plate rack**  
8100 303

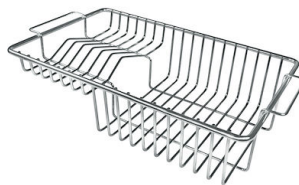

**Stainless steel plate rack**  
8100 201



**Stainless steel basket**  
8611 000

\* only in combination with the accessory 8644 101



**White bowl**  
8153 100

## RECOMMENDED PAIRINGS



**Cooker hob KE**  
7602 032

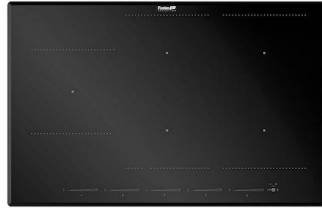

**Cooker hob KE Induction**  
7386 646



**Mixer Tap Omega Plus**  
8497 020



## OPTIONAL AUTOMATIC WASTE FITTINGS



**Automatic waste fitting - PM**  
8407 113



**Space automatic waste fitting - PA**  
8407 108



**Space automatic waste fitting - PE**  
8407 109



**Space Light automatic waste fitting  
- PL**  
8407 117



**Space Push automatic waste fitting  
- PP**  
8407 116